

**RADIATION HARDENED
 POWER MOSFET
 THRU-HOLE (TO-257AA)**

**IRHY67434CM
 550V, N-CANNEL
 TECHNOLOGY**

Product Summary

Part Number	Radiation Level	R _{DS(on)}	I _D
IRHY67434CM	100K Rads (Si)	3.0Ω	3.4A
IRHY63434CM	300K Rads (Si)	3.0Ω	3.4A

International Rectifier's R6™ technology provides superior power MOSFETs for space applications. These devices have improved immunity to Single Event Effect (SEE) and have been characterized for useful performance with Linear Energy Transfer (LET) up to 90MeV/(mg/cm²).

Their combination of very low R_{DS(on)} and faster switching times reduces power loss and increases power density in today's high speed switching applications such as DC-DC converters and motor controllers. These devices retain all of the well established advantages of MOSFETs such as voltage control, ease of paralleling and temperature stability of electrical parameters.

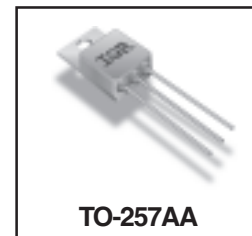

TO-257AA

Features:

- Low R_{DS(on)}
- Fast Switching
- Single Event Effect (SEE) Hardened
- Low Total Gate Charge
- Simple Drive Requirements
- Ease of Paralleling
- Hermetically Sealed
- Ceramic Eyelets
- Electrically Isolated
- Light Weight

Absolute Maximum Ratings

Pre-Irradiation

	Parameter		Units
I _D @ V _{GS} = 12V, T _C = 25°C	Continuous Drain Current	3.4	A
I _D @ V _{GS} = 12V, T _C = 100°C	Continuous Drain Current	2.1	
I _{DM}	Pulsed Drain Current ①	13.6	
P _D @ T _C = 25°C	Max. Power Dissipation	75	W
	Linear Derating Factor	0.6	W/°C
V _{GS}	Gate-to-Source Voltage	±20	V
EAS	Single Pulse Avalanche Energy ②	97	mJ
I _{AR}	Avalanche Current ①	3.4	A
E _{AR}	Repetitive Avalanche Energy ①	7.5	mJ
dv/dt	Peak Diode Recovery dv/dt ③	8.1	V/ns
T _J	Operating Junction	-55 to 150	°C
T _{STG}	Storage Temperature Range		
	Lead Temperature	300 (0.063 in. /1.6 mm from case for 10s)	
	Weight	4.3 (Typical)	g

For footnotes refer to the last page

Electrical Characteristics @ T_j = 25°C (Unless Otherwise Specified)

	Parameter	Min	Typ	Max	Units	Test Conditions
B _V DSS	Drain-to-Source Breakdown Voltage	550	—	—	V	V _{GS} = 0V, I _D = 1.0mA
ΔB _V DSS/ΔT _J	Temperature Coefficient of Breakdown Voltage	—	0.51	—	V/°C	Reference to 25°C, I _D = 1.0mA
R _D S(on)	Static Drain-to-Source On-State Resistance	—	—	3.0	Ω	V _{GS} = 12V, I _D = 2.1A ④
V _{GS(th)}	Gate Threshold Voltage	2.0	—	4.0	V	V _{DS} = V _{GS} , I _D = 1.0mA
g _{fs}	Forward Transconductance	3.7	—	—	S	V _{DS} = 15V, I _{DS} = 2.1A ④
I _{DSS}	Zero Gate Voltage Drain Current	—	—	10	μA	V _{DS} = 440V, V _{GS} = 0V
		—	—	25		V _{DS} = 440V, V _{GS} = 0V, T _J = 125°C
I _{GSS}	Gate-to-Source Leakage Forward	—	—	100	nA	V _{GS} = 20V
I _{GSS}	Gate-to-Source Leakage Reverse	—	—	-100		V _{GS} = -20V
Q _g	Total Gate Charge	—	—	35	nC	V _{GS} = 12V, I _D = 3.4A
Q _{gs}	Gate-to-Source Charge	—	—	12		V _{DS} = 275V
Q _{gd}	Gate-to-Drain ('Miller') Charge	—	—	15		
t _{d(on)}	Turn-On Delay Time	—	—	18	ns	V _{DD} = 275V, I _D = 3.4A
t _r	Rise Time	—	—	7.5		V _{GS} = 12V, R _G = 7.5Ω
t _{d(off)}	Turn-Off Delay Time	—	—	31		
t _f	Fall Time	—	—	14		
L _S + L _D	Total Inductance	—	6.8	—	nH	Measured from Drain lead (6mm / 0.25in. from package) to Source lead (6mm / 0.25in. from package)
C _{iss}	Input Capacitance	—	1267	—	pF	V _{GS} = 0V, V _{DS} = 25V
C _{oss}	Output Capacitance	—	79	—		f = 1.0MHz
C _{rss}	Reverse Transfer Capacitance	—	1.1	—		
R _g	Internal Gate Resistance	—	1.1	—		Ω

Source-Drain Diode Ratings and Characteristics

	Parameter	Min	Typ	Max	Units	Test Conditions
I _S	Continuous Source Current (Body Diode)	—	—	3.4	A	
I _{SM}	Pulse Source Current (Body Diode) ①	—	—	13.6		
V _{SD}	Diode Forward Voltage	—	—	1.0	V	T _J = 25°C, I _S = 3.4A, V _{GS} = 0V ④
t _{rr}	Reverse Recovery Time	—	—	741	ns	T _J = 25°C, I _F = 3.4A, di/dt ≤ 100A/μs
Q _{RR}	Reverse Recovery Charge	—	—	2.1	nC	V _{DD} ≤ 50V ④
t _{on}	Forward Turn-On Time	Intrinsic turn-on time is negligible. Turn-on speed is substantially controlled by L _S + L _D .				

Thermal Resistance

	Parameter	Min	Typ	Max	Units	Test Conditions
R _{thJC}	Junction-to-Case	—	—	1.67	°C/W	
R _{thJA}	Junction-to-Ambient	—	—	80		Typical Socket Mount

Note: Corresponding Spice and Saber models are available on International Rectifier Web site.

For footnotes refer to the last page

Radiation Characteristics

IRHY67434CM

International Rectifier Radiation Hardened MOSFETs are tested to verify their radiation hardness capability. The hardness assurance program at International Rectifier is comprised of two radiation environments. Every manufacturing lot is tested for total ionizing dose (per notes 5 and 6) using the TO-3 package. Both pre- and post-irradiation performance are tested and specified using the same drive circuitry and test conditions in order to provide a direct comparison.

Table 1. Electrical Characteristics @ Tj = 25°C, Post Total Dose Irradiation ⑤⑥

	Parameter	Up to 300K Rads (Si) ¹		Units	Test Conditions
		Min	Max		
BV _{DSS}	Drain-to-Source Breakdown Voltage	550	—	V	V _{GS} = 0V, I _D = 1.0mA
V _{GS(th)}	Gate Threshold Voltage	2.0	4.0		V _{GS} = V _{DS} , I _D = 1.0mA
I _{GSS}	Gate-to-Source Leakage Forward	—	100	nA	V _{GS} = 20V
I _{GSS}	Gate-to-Source Leakage Reverse	—	-100		V _{GS} = -20V
I _{DSS}	Zero Gate Voltage Drain Current	—	10	μA	V _{DS} = 440V, V _{GS} = 0V
R _{DS(on)}	Static Drain-to-Source On-State Resistance (TO-3) ④	—	2.9	Ω	V _{GS} = 12V, I _D = 2.1A
V _{SD}	Diode Forward Voltage ④	—	1.0	V	V _{GS} = 0V, I _D = 3.4A

1. Part numbers: IRHY67434CM and IRHY63434CM

International Rectifier radiation hardened MOSFETs have been characterized in heavy ion environment for Single Event Effects (SEE). Single Event Effects characterization is illustrated in Fig. a and Table 2.

Table 2. Typical Single Event Effect Safe Operating Area

Ion	LET (MeV/(mg/cm ²))	Energy (MeV)	Range (μm)	V _{DS} (V)			
				@V _{GS} =-0V	@V _{GS} =-4V	@V _{GS} =-12V	@V _{GS} =-20V
Kr	32.4	679	83.3	550	550	550	550
Xe	56.2	1060	83.5	550	550	550	-
Au	89.5	1555	84	550	550	-	-

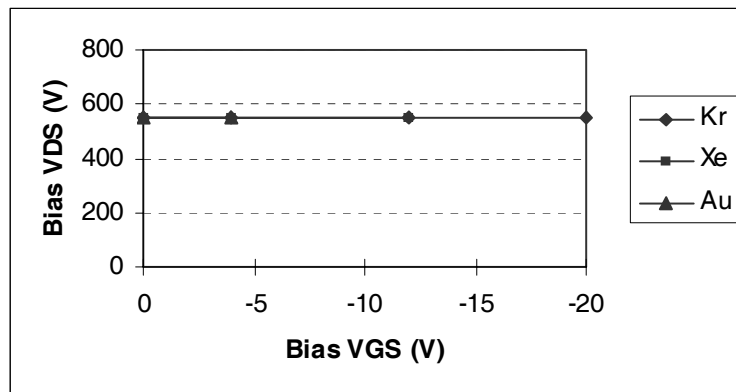

Fig a. Typical Single Event Effect, Safe Operating Area

For footnotes refer to the last page

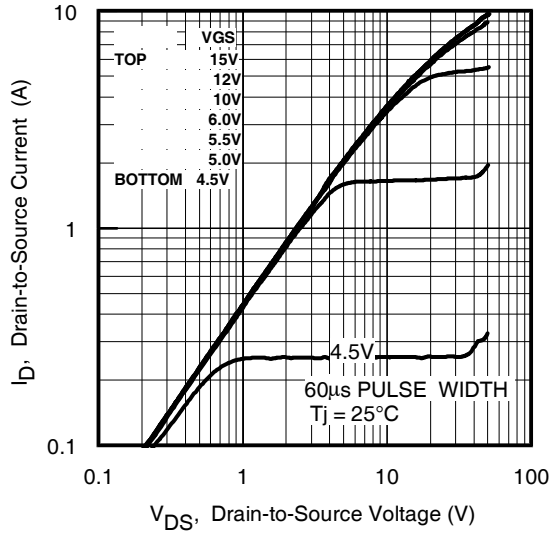

Fig 1. Typical Output Characteristics

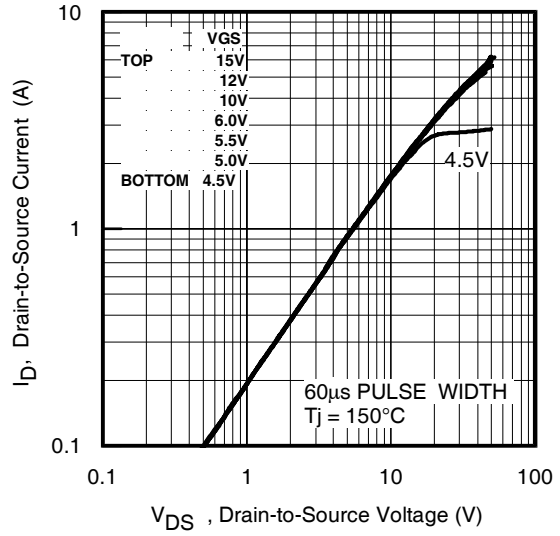

Fig 2. Typical Output Characteristics

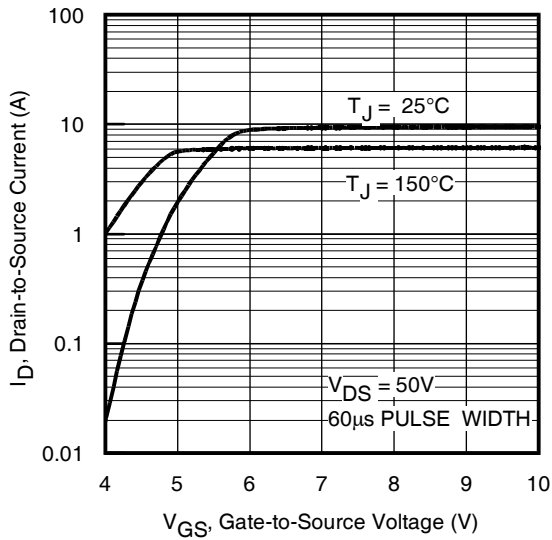

Fig 3. Typical Transfer Characteristics

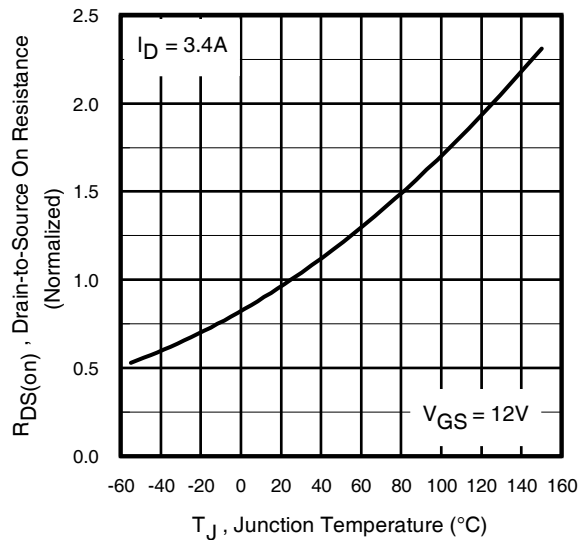

Fig 4. Normalized On-Resistance Vs. Temperature

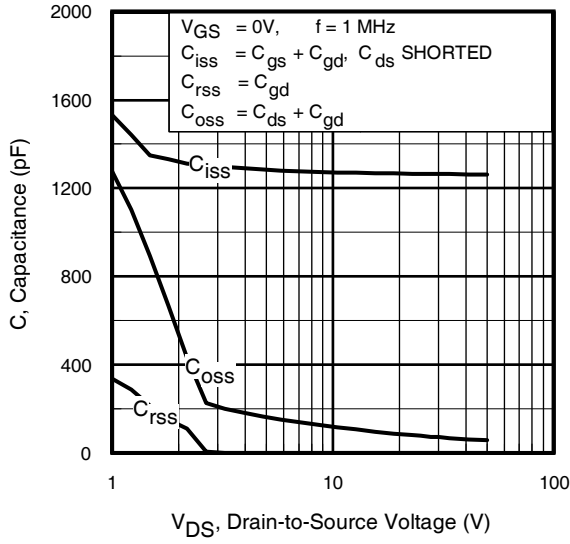

Fig 5. Typical Capacitance Vs. Drain-to-Source Voltage

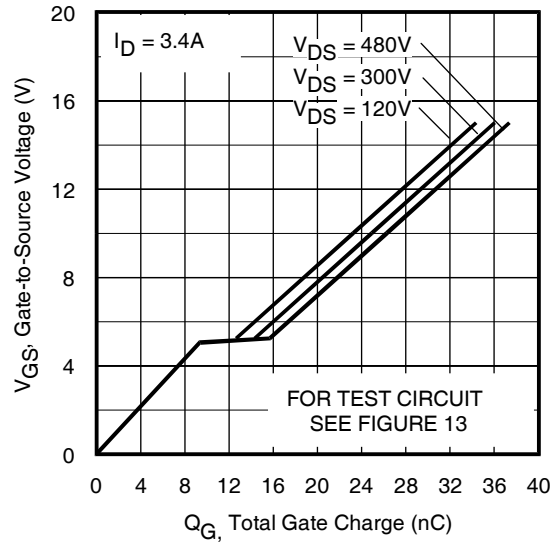

Fig 6. Typical Gate Charge Vs. Gate-to-Source Voltage

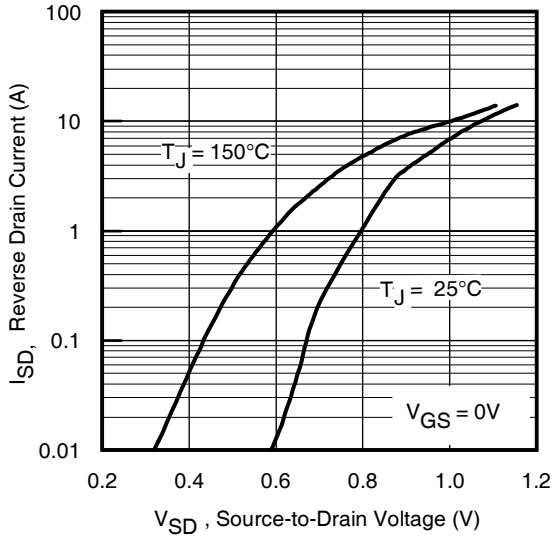

Fig 7. Typical Source-Drain Diode Forward Voltage

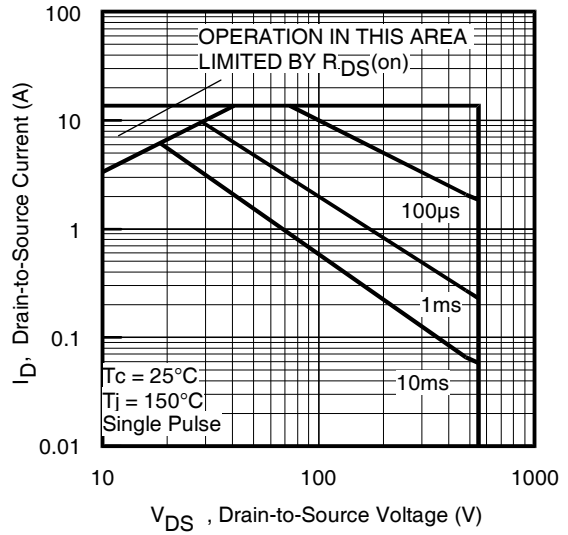

Fig 8. Maximum Safe Operating Area

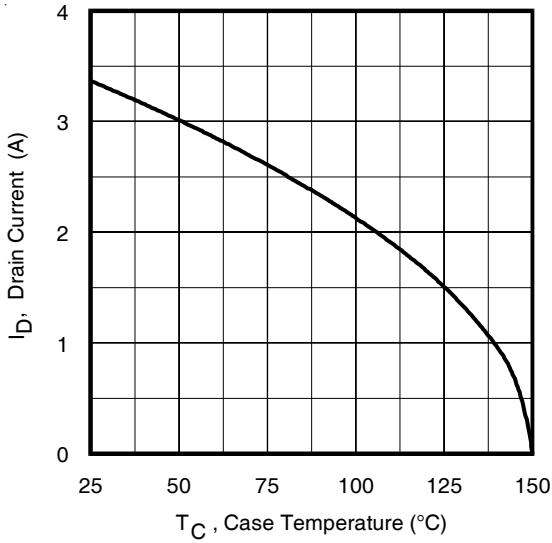

Fig 9. Maximum Drain Current Vs. Case Temperature

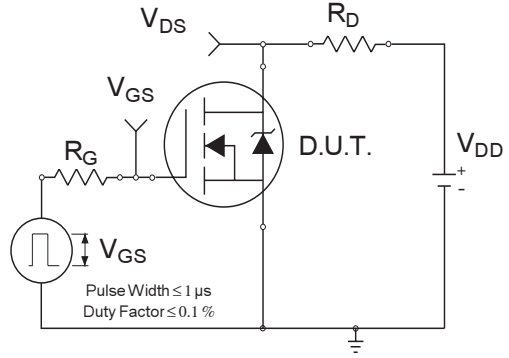

Fig 10a. Switching Time Test Circuit

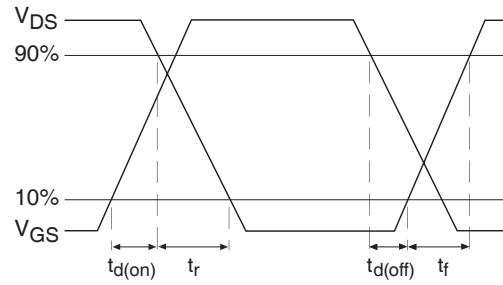

Fig 10b. Switching Time Waveforms

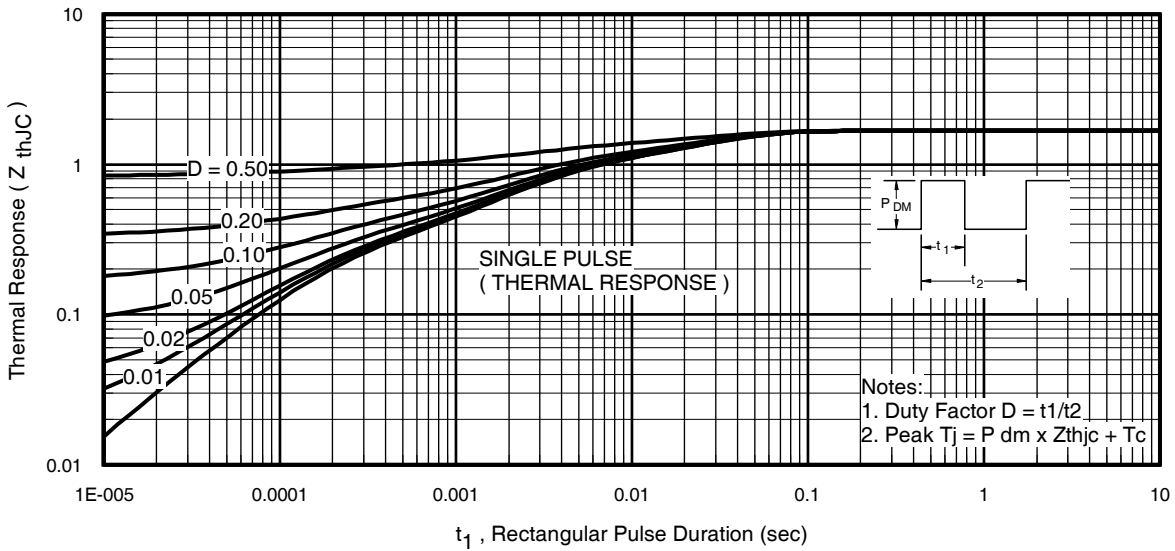

Fig 11. Maximum Effective Transient Thermal Impedance, Junction-to-Case

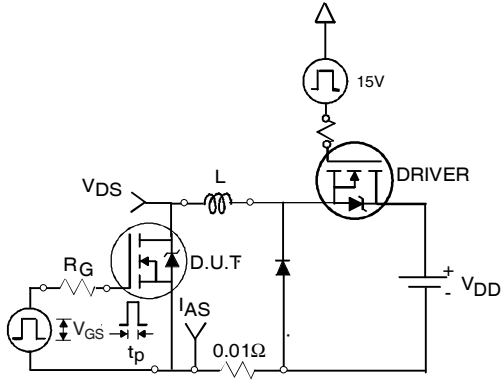

Fig 12a. Unclamped Inductive Test Circuit

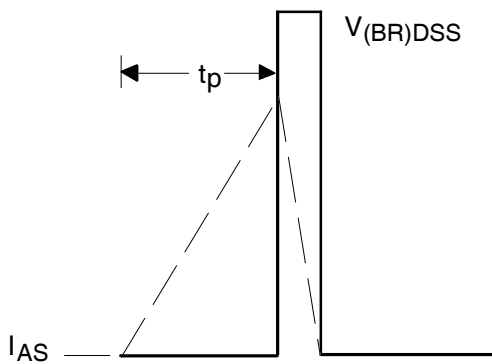

Fig 12b. Unclamped Inductive Waveforms

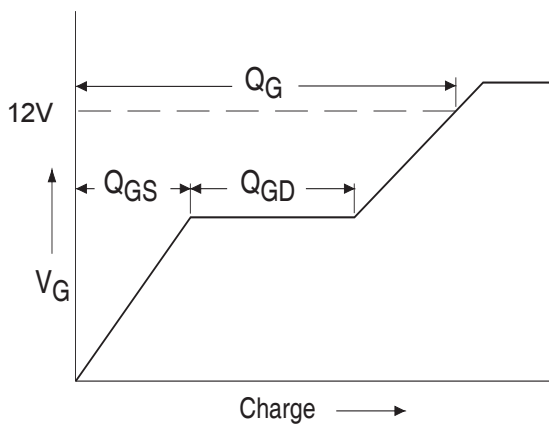

Fig 13a. Basic Gate Charge Waveform

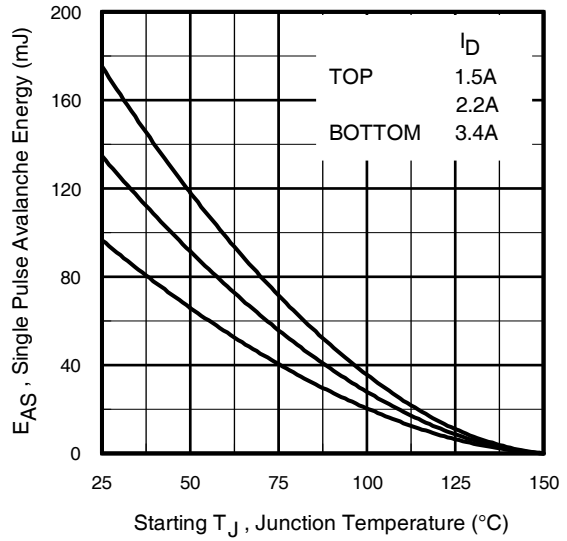

Fig 12c. Maximum Avalanche Energy Vs. Drain Current

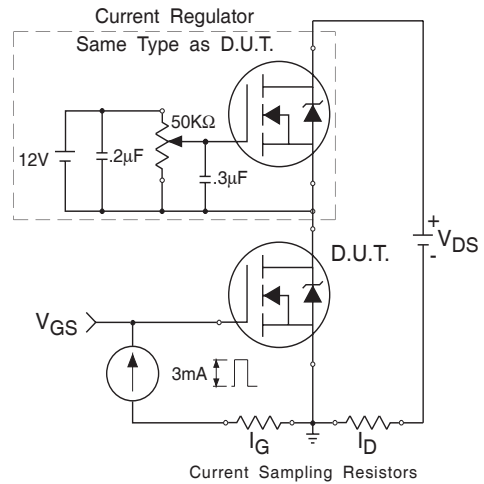

Fig 13b. Gate Charge Test Circuit

IRHY67434CM

Pre-Irradiation

Footnotes:

- ① Repetitive Rating; Pulse width limited by maximum junction temperature.
- ② $V_{DD} = 50V$, starting $T_J = 25^\circ C$, $L = 16.7mH$
Peak $I_L = 3.4A$, $V_{GS} = 12V$
- ③ $I_{SD} \leq 3.4A$, $di/dt \leq 560A/\mu s$,
 $V_{DD} \leq 550V$, $T_J \leq 150^\circ C$
- ④ Pulse width $\leq 300 \mu s$; Duty Cycle $\leq 2\%$
- ⑤ **Total Dose Irradiation with VGS Bias.**
12 volt V_{GS} applied and $V_{DS} = 0$ during irradiation per MIL-STD-750, method 1019, condition A.
- ⑥ **Total Dose Irradiation with VDS Bias.**
440 volt V_{DS} applied and $V_{GS} = 0$ during irradiation per MIL-STD-750, method 1019, condition A.

Case Outline and Dimensions — TO-257AA

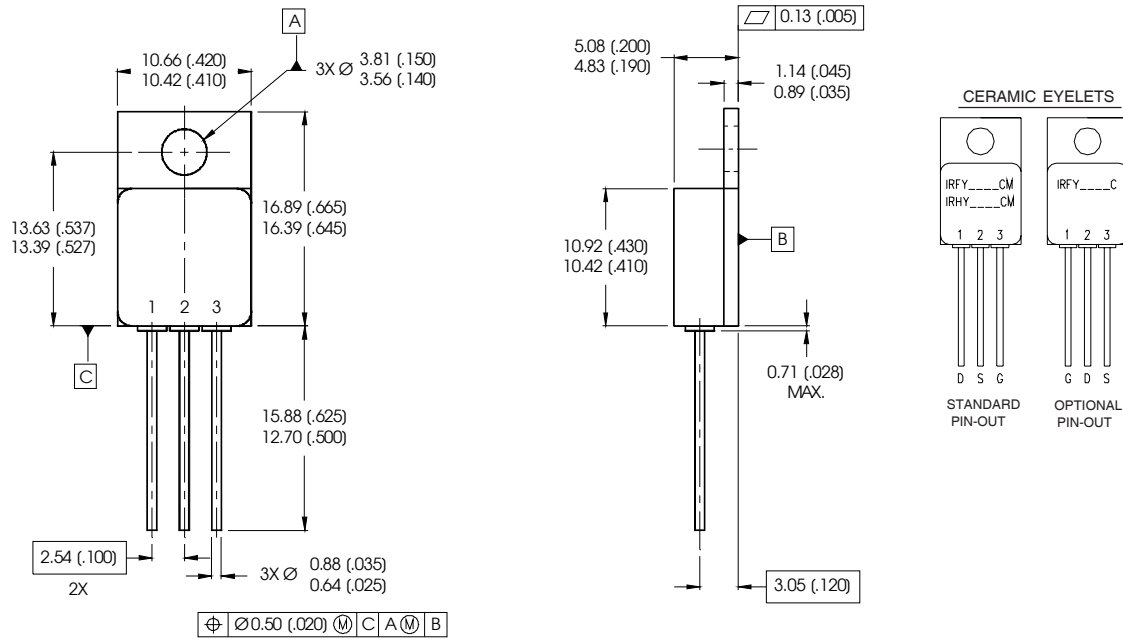

NOTES:

1. DIMENSIONING & TOLERANCING PER ANSI Y14.5M-1994.
2. CONTROLLING DIMENSION: INCH.
3. DIMENSIONS ARE SHOWN IN MILLIMETERS (INCHES).
4. OUTLINE CONFORMS TO JEDEC OUTLINE TO-257AA.

PIN ASSIGNMENTS

- 1 = DRAIN
- 2 = SOURCE
- 3 = GATE

CAUTION

BERYLLIA WARNING PER MIL-PRF-19500

Package containing beryllia shall not be ground, sandblasted, machined, or have other operations performed on them which will produce beryllia or beryllium dust. Furthermore, beryllium oxide packages shall not be placed in acids that will produce fumes containing beryllium.

International
IOR Rectifier

IR WORLD HEADQUARTERS: 101 N. Sepulveda Blvd, El Segundo, California 90245, USA Tel: (310) 252-7105

IR LEOMINSTER : 205 Crawford St., Leominster, Massachusetts 01453, USA Tel: (978) 534-5776

TAC Fax: (310) 252-7903

Visit us at www.irf.com for sales contact information.

Data and specifications subject to change without notice. 01/2013